

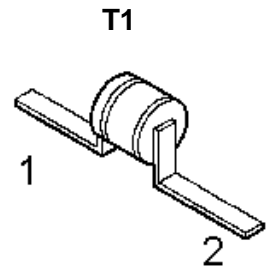

HiRel Silicon PIN Diode

- **HiRel Discrete and Microwave Semiconductor**
- Current controlled RF resistor for RF attenuators and switches
- High reverse voltage
- Hermetically sealed microwave package
-  **ESA Space Qualified**
ESA/SCC Detail Spec. No.: 5513/030
Type Variant No.s 01 to 03

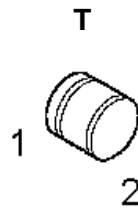

ESD: Electrostatic discharge sensitive device, observe handling precautions!

Type	Marking	Ordering Code	Pin Configuration	Package
BXY43-T (q)	-	see below		T
BXY43-T1 (q)				T1

(q) Quality Level: P: Professional Quality
 H: High Rel Quality
 S: Space Quality
 ES: ESA Space Quality

(see order instructions for ordering example)

Maximum Ratings

Parameter	Symbol	Values	Unit
Reverse Voltage	V_R	150	V
Forward Current	I_F	400	mA
Power Dissipation ¹⁾	P_{tot}	500	mW
Operating Temperature Range	T_{op}	-55 to +150	°C
Storage Temperature Range	T_{stg}	-65 to +175	°C
Soldering Temperature ²⁾	T_{sol}	+235	°C
Junction Temperature	T_j	150	°C
Thermal Resistance Junction-Case	$R_{th(j-c)}$		K/W
BXY43-T		100	
BXY43-T1		125	

Notes.:

- 1.) For BXY43-T: At $T_{CASE} = 100$ °C. For $T_{CASE} > 100$ °C derating is required.
For BXY43-T1: At $T_{CASE} = 87,5$ °C. For $T_{CASE} > 87,5$ °C derating is required.
- 2.) During 5 sec. maximum. The same terminal shall not be resoldered until 5 minutes have elapsed.

Electrical Characteristics

at $T_A=25$ °C; unless otherwise specified

Parameter	Symbol	Values			Unit
		min.	typ.	max.	
DC Characteristics					
Reverse Current 1 $V_{R1}=150V$	I_{R1}	-	-	100	nA
Reverse Current 2 $V_{R2}=100V$	I_{R2}	-	-	10	nA
Forward Voltage $I_F=100mA$	V_F	-	0,97	1	V

Electrical Characteristics (continued)

Parameter	Symbol	Values			Unit
		min.	typ.	max.	
AC Characteristics					
Total Capacitance $V_R=50V$; $f=1MHz$ BXY43-T, -T1	C_T	-	0,3	0,45	pF
Forward Resistance 1 $f=100MHz$, $I_{F1}=20\mu A$	R_{F1}	-	55	70	Ω
Forward Resistance 2 $f=100MHz$, $I_{F2}=1mA$	R_{F2}	-	2,2	3,0	Ω
Forward Resistance 3 $f=100MHz$, $I_{F3}=10mA$	R_{F3}	-	0,9	1,5	Ω
Minority Carrier Lifetime $I_F=10mA$, $I_R=6mA$, $I_R=3mA$	τ_L	250	650		ns

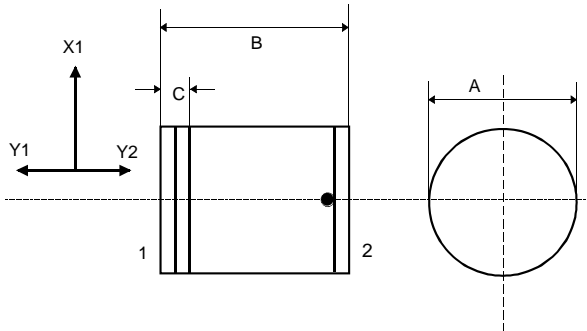
T Package

Symbol	Millimetre	
	min	max
A	1,30	1,45
B	1,15	1,35
C	-	0,40

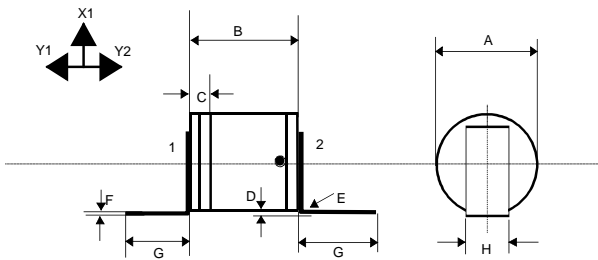
T1 Package

Symbol	Millimetre	
	min	max
A	1,30	1,45
B	1,15	1,35
C	-	0,40
D	0,10	0,50
E	-	0,30
F	0,06	0,10
G	5,50	-
H	0,40	0,60

Edition 2011-02

Published by

Infineon Technologies AG

85579 Neubiberg, Germany

© Infineon Technologies AG 2011

All Rights Reserved.

Attention please!

The information given in this document shall in no event be regarded as a guarantee of conditions or characteristics ("Beschaffenheitsgarantie"). With respect to any examples or hints given herein, any typical values stated herein and/or any information regarding the application of the device, Infineon Technologies hereby disclaims any and all warranties and liabilities of any kind, including without limitation warranties of non-infringement of intellectual property rights of a third party.

Information

For further information on technology, delivery terms and conditions and prices please contact your nearest Infineon Technologies Office (www.infineon.com).

Warnings

Due to technical requirements components may contain dangerous substances. For information on the types in question please contact your nearest Infineon Technologies Office.

Infineon Technologies Components may only be used in life-support devices or systems with the express written approval of Infineon Technologies, if a failure of such components can reasonably be expected to cause the failure of that life-support device or system, or to affect the safety or effectiveness of that device or system.

Life support devices or systems are intended to be implanted in the human body, or to support and/or maintain and sustain and/or protect human life. If they fail, it is reasonable to assume that the health of the user or other persons may be endangered.